

TVS Diodes

Transient Voltage Suppression Diodes

P6SMB Series



Description

Transient Voltage Suppressor (TVS) is a circuit protection component that either attenuates (reduces) or filters a transient voltage spike (overvoltage), TVS diodes provide critical protection by going into avalanche breakdown within no more than a few nanoseconds after a strike, clamping the transient voltage, and routing its current to the ground.

Applications

- Communication Equipment
- Security & Protection
- Industrial Control Equipment
- Power Supply
- Automotive Electronics
- New Energy
- Lightning Protection

Features

- Low incremental surge resistance
- Excellent clamping capability
- Low profile package with built-in strain relief
- Typical I_R less than 1.0 μA above 12 V
- 600 W peak pulse power capability with a 10/1000 μs Waveform, repetition rate (duty cycle): 0.01%
- For surface mounted applications to optimize board space
- Typical failure mode is short from over-specified voltage or current
- IEC 61000-4-2 ESD 30 kV (Air), 30 kV (Contact)
- EFT protection of data lines in accordance with IEC 61000-4-4
- Very fast response time
- Glass passivated chip junction
- High temperature to reflow soldering guaranteed: 260 $^{\circ}C/30sec$
- $V_{BR} @ T_J = V_{BR@25^{\circ}C} \times (1 + \alpha T \times (T_J - 25))$
(αT : Temperature Coefficient, typical value is 0.1%)
- Plastic package is flammability rated V-0 per Underwriters Laboratories
- Meet MSL level1, per J-STD-020
- Matte tin lead-free plated
- Halogen free and RoHS compliant
- Pb-free E3 means 2nd level interconnect is Pb-free and the terminal finish material is tin(Sn) (IPC/JEDEC J-STD-609A.01)

Functional Diagram

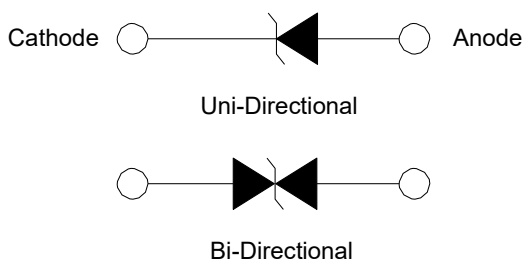

TVS Diodes

Transient Voltage Suppression Diodes

P6SMB Series

Package Outline Dimensions (DO-214AA)

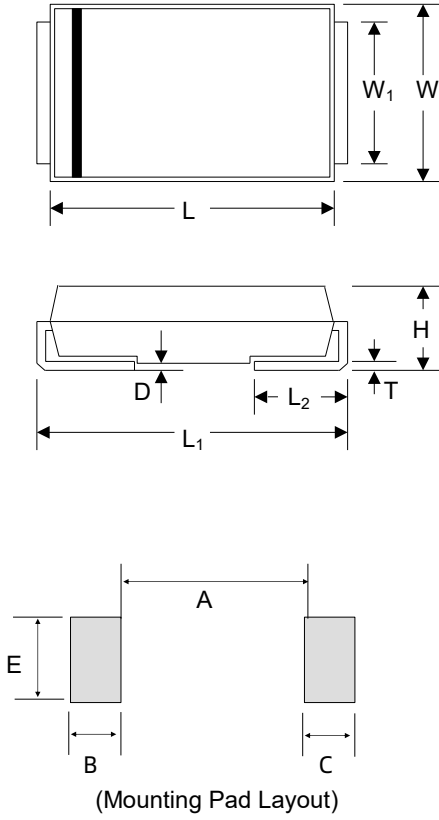

Symbol	Millimeters		Inches	
	Min.	Max.	Min.	Max.
L	4.06	4.75	0.160	0.187
W	3.30	3.94	0.130	0.155
W_1	1.93	2.20	0.076	0.086
H	1.99	2.61	0.078	0.103
T	0.152	0.305	0.0086	0.012
L_1	5.21	5.59	0.205	0.220
L_2	0.76	1.52	0.030	0.060
D	-	0.203	-	0.008
A	-	2.74	-	0.107
B	2.16	-	0.085	-
C	2.16	-	0.085	-
E	2.26	-	0.089	-

Maximum Ratings and Characteristics

(Ratings at 25 °C ambient temperature unless otherwise specified.)

Parameter	Symbol	Value	Unit
Peak Pulse Power Dissipation (Fig2) with a 10/1000 μ s Test Waveform ⁽¹⁾⁽²⁾ (Fig4)-Signal Die Parts	P _{PPM}	600	W
Peak Pulse Power Dissipation((Fig2) with a 10/1000 μ s Test Waveform(1)(2)(Fig4)--Stacked Die Parts ⁽⁵⁾	P _{PPM}	800	W
Peak Power Dissipation on Infinite Heat Sink at T _L =50 °C	P _D	5.0	W
Peak Forward Surge Current,8.3 ms single half sinewave superimposed on rated load (JEDEC Method) ⁽³⁾	I _{FSM}	100	A
Maximum Instantaneous Forward Voltage at 50 A for Unidirectional Only ⁽⁴⁾	V _F	3.5/5.0	V
Operating Temperature Range	T _J	-65 to 150	°C
Storage Temperature Range	T _{STG}	-65 to 175	°C
Typical Thermal Resistance Junction to Lead	R _{θJL}	20	°C / W
Typical Thermal Resistance Junction to Ambient	R _{θJA}	100	°C / W

Notes

1. Non-repetitive current pulse, per Fig. 4 and derated above T_J(initial)=25 °C per Fig. 3.
2. Mounted on 5.0 mm² land areas.
3. Measured of 8.3 ms single half sine-wave or equivalent square wave, duty cycle=4 pulses per minute maximum.
4. V_F < 3.5 V for single die parts and V_F< 5.0 V for stacked-die parts.
5. For stacked die component details, please refer to part numbers labeled by * in Electrical Characteristics.

TVS Diodes

Transient Voltage Suppression Diodes

P6SMB Series

Part Numbering System

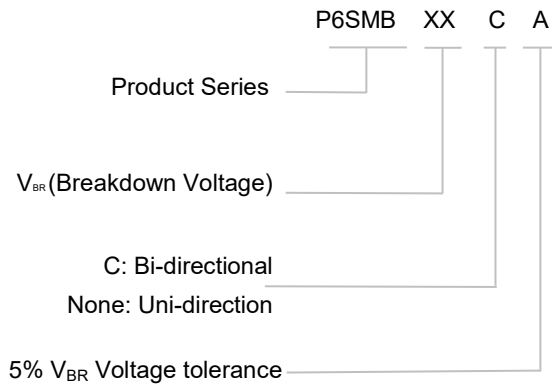

Marking

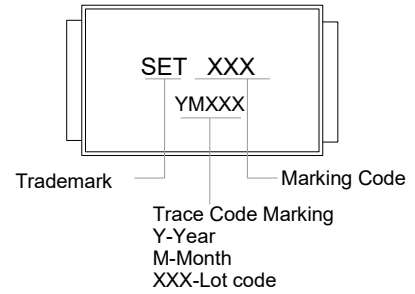
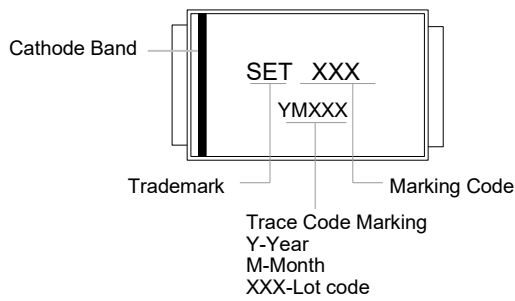

TVS Diodes

Transient Voltage Suppression Diodes

P6SMB Series

Electrical Characteristics (T_A=25°C unless otherwise noted)

Part Number		Device Marking Code		Breakdown Voltage V _{BR} @I _T		Test Current I _T	Reverse Stand-off Voltage V _R	Max. Reverse Leakage I _R @V _R	Max. Peak Pulse Current I _{PPM}	Max. Clamping Voltage V _C @I _{PPM}
Uni	Bi	Uni	Bi	Min	Max					
				(V)		(mA)	(V)	(μA)	(A)	(V)
P6SMB6.8A	P6SMB6.8CA	6V8A	6V8C	6.45	7.14	10	5.80	500.00	58.10	10.50
P6SMB7.5A	P6SMB7.5CA	7V5A	7V5C	7.13	7.88	10	6.40	300.00	54.00	11.30
P6SMB8.2A	P6SMB8.2CA	8V2A	8V2C	7.79	8.61	10	7.02	100.00	50.40	12.10
P6SMB9.1A	P6SMB9.1CA	9V1A	9V1C	8.65	9.55	1	7.78	50.00	45.50	13.40
P6SMB10A	P6SMB10CA	10A	10C	9.50	10.50	1	8.55	10.00	42.10	14.50
P6SMB11A	P6SMB11CA	11A	11C	10.50	11.60	1	9.40	5.00	39.10	15.60
P6SMB12A	P6SMB12CA	12A	12C	11.40	12.60	1	10.20	5.00	36.50	16.70
P6SMB13A	P6SMB13CA	13A	13C	12.40	13.70	1	11.10	1.00	33.50	18.20
P6SMB15A	P6SMB15CA	15A	15C	14.30	15.80	1	12.80	1.00	28.80	21.20
P6SMB16A	P6SMB16CA	16A	16C	15.20	16.80	1	13.60	1.00	27.10	22.50
P6SMB18A	P6SMB18CA	18A	18C	17.10	18.90	1	15.30	1.00	24.20	25.50
P6SMB20A	P6SMB20CA	20A	20C	19.00	21.00	1	17.10	1.00	22.00	27.70
P6SMB22A	P6SMB22CA	22A	22C	20.90	23.10	1	18.80	1.00	19.90	30.60
P6SMB24A	P6SMB24CA	24A	24C	22.80	25.20	1	20.50	1.00	18.40	33.20
P6SMB27A	P6SMB27CA	27A	27C	25.70	28.40	1	23.10	1.00	16.30	37.50
P6SMB30A	P6SMB30CA	30A	30C	28.50	31.50	1	25.60	1.00	14.70	41.40
P6SMB33A	P6SMB33CA	33A	33C	31.40	34.70	1	28.20	1.00	13.30	45.70
P6SMB36A	P6SMB36CA	36A	36C	34.20	37.80	1	30.80	1.00	12.20	49.90
P6SMB39A	P6SMB39CA	39A	39C	37.10	41.00	1	33.30	1.00	11.30	53.90
P6SMB43A	P6SMB43CA	43A	43C	40.90	45.20	1	36.80	1.00	10.30	59.30
P6SMB47A	P6SMB47CA	47A	47C	44.70	49.40	1	40.20	1.00	9.40	64.80
P6SMB51A	P6SMB51CA	51A	51C	48.50	53.60	1	43.60	1.00	8.70	70.10
P6SMB56A	P6SMB56CA	56A	56C	53.20	58.80	1	47.80	1.00	7.90	77.00

TVS Diodes

Transient Voltage Suppression Diodes

P6SMB Series

Part Number		Device Marking Code		Breakdown Voltage $V_{BR@I_T}$		Test Current I_T	Reverse Stand-off Voltage V_R	Max. Reverse Leakage $I_R@V_R$	Max. Peak Pulse Current I_{PPM}	Max. Clamping Voltage $V_C@I_{PPM}$
				Min	Max					
Uni	Bi	Uni	Bi	(V)		(mA)	(V)	(μ A)	(A)	(V)
P6SMB58A	P6SMB58CA	58A	58C	55.10	60.90	1	52.78	1.00	7.70	79.80
P6SMB62A	P6SMB62CA	62A	62C	58.90	65.10	1	53.00	1.00	7.20	85.00
P6SMB68A	P6SMB68CA	68A	68C	64.60	71.40	1	58.10	1.00	6.60	92.00
P6SMB75A	P6SMB75CA	75A	75C	71.30	78.80	1	64.10	1.00	5.90	103.00
P6SMB82A	P6SMB82CA	82A	82C	77.90	86.10	1	70.10	1.00	5.40	113.00
P6SMB91A	P6SMB91CA	91A	91C	86.50	95.50	1	77.80	1.00	4.90	125.00
P6SMB100A	P6SMB100CA	100A	100C	95.00	105.00	1	85.50	1.00	4.50	137.00
P6SMB110A	P6SMB110CA	110A	110C	105.00	116.00	1	94.00	1.00	4.00	152.00
P6SMB120A	P6SMB120CA	120A	120C	114.00	126.00	1	102.00	1.00	3.70	165.00
P6SMB130A	P6SMB130CA	130A	130C	124.00	137.00	1	111.00	1.00	3.40	179.00
P6SMB150A	P6SMB150CA	150A	150C	143.00	158.00	1	128.00	1.00	2.90	207.00
P6SMB160A	P6SMB160CA	160A	160C	152.00	168.00	1	136.00	1.00	2.80	219.00
P6SMB170A	P6SMB170CA	170A	170C	162.00	179.00	1	145.00	1.00	2.60	234.00
P6SMB180A	P6SMB180CA	180A	180C	171.00	189.00	1	154.00	1.00	2.50	246.00
P6SMB200A	P6SMB200CA	200A	200C	190.00	210.00	1	171.00	1.00	2.20	274.00
P6SMB220A	P6SMB220CA	220A	220C	209.00	231.00	1	185.00	1.00	1.90	328.00
P6SMB250A	P6SMB250CA	250A	250C	237.00	263.00	1	214.00	1.00	1.80	344.00
P6SMB300A	P6SMB300CA	300A	300C	285.00	315.00	1	256.00	1.00	1.50	414.00
P6SMB350A*	P6SMB350CA*	350A	350C	332.00	368.00	1	300.00	1.00	1.30	482.00
P6SMB400A*	P6SMB400CA*	400A	400C	380.00	420.00	1	342.00	1.00	1.10	548.00
P6SMB440A*	P6SMB440CA*	440A	440C	418.00	462.00	1	376.00	1.00	1.00	602.00
P6SMB480A*	P6SMB480CA*	480A	480C	456.00	504.00	1	408.00	1.00	0.90	658.00
P6SMB510A*	P6SMB510CA*	510A	510C	485.00	535.00	1	434.00	1.00	0.90	698.00
P6SMB530A*	P6SMB530CA*	530A	530C	503.50	556.50	1	451.00	1.00	0.80	725.00
P6SMB540A*	P6SMB540CA*	540A	540C	513.00	567.00	1	460.00	1.00	0.80	740.00
P6SMB550A*	P6SMB550CA*	550A	550C	522.50	577.50	1	468.00	1.00	0.80	760.00
P6SMB600A*	P6SMB600CA*	600A	600C	570.00	630.00	1	512.00	1.00	0.75	828.00

Notes:

- For bidirectional type having V_R of 10 volts and less, the I_R should be doubled.
- For parts without A in the PN, the V_{BR} tolerance is $\pm 10\%$ and V_C is 5% higher than parts with A. The parts without A are currently available, but not recommended for new designs. The parts with A are preferred.
- For stacked die component details, please refer to models marked with * in electrical characteristics table.

TVS Diodes

Transient Voltage Suppression Diodes

P6SMB Series

I-V Curve Characteristics

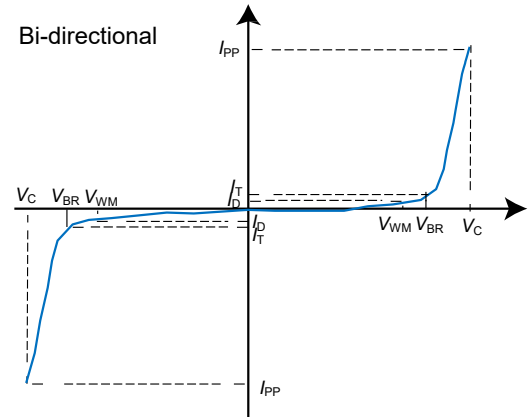
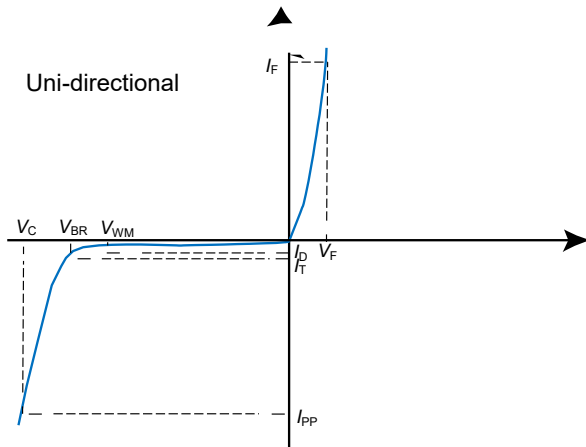

Performance Curve for Reference ($T_A=25^\circ\text{C}$ unless otherwise noted)

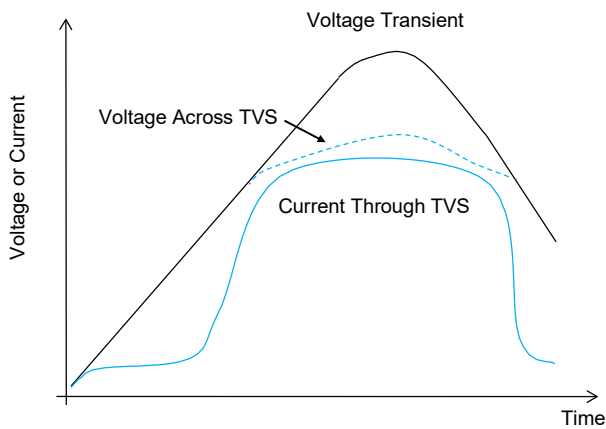

FIGURE 1 TVS Transients Clamping Waveform

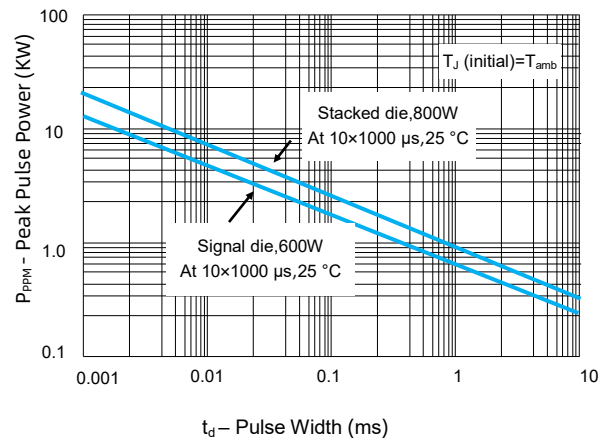

FIGURE 2 Peak Pulse Power Rating Curve

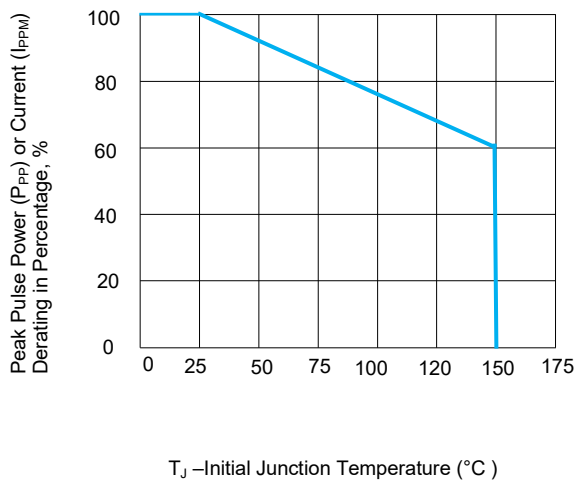

FIGURE 3 Peak Pulse Power Derating Curve

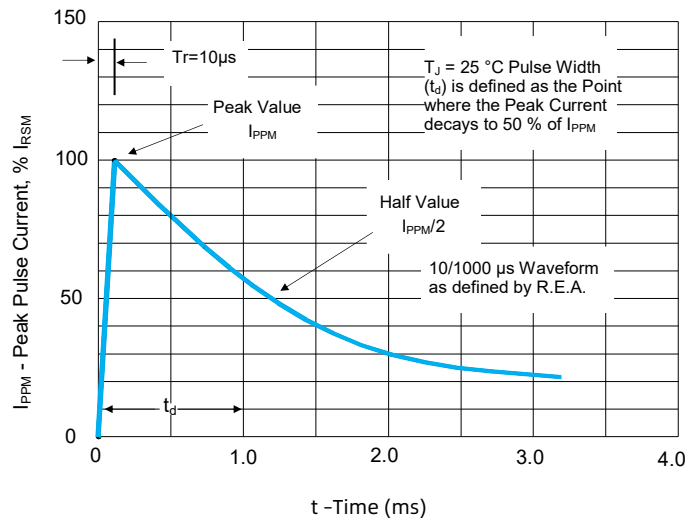

FIGURE 4 Pulse Waveform

TVS Diodes

Transient Voltage Suppression Diodes

P6SMB Series

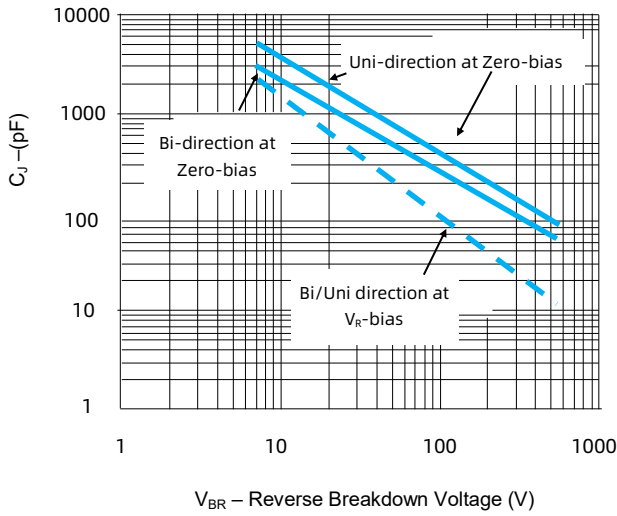

FIGURE 5 Typical Junction Capacitance

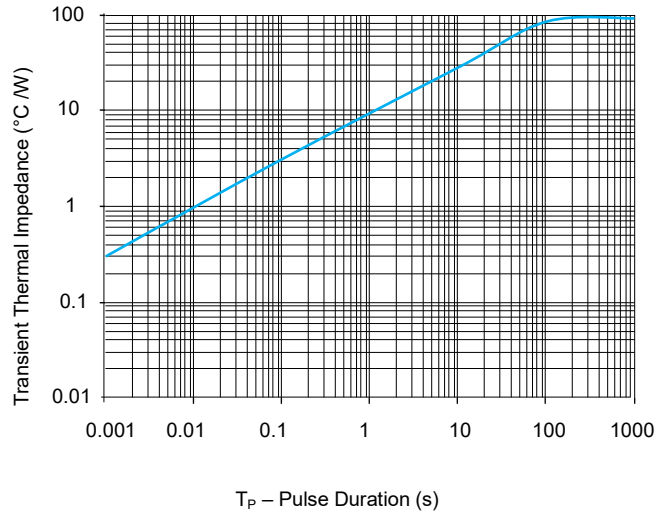

FIGURE 6 Typical Transient Thermal Impedance

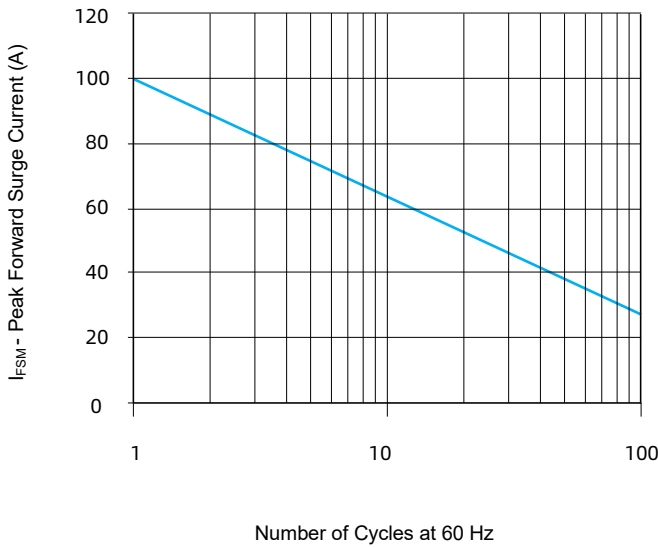

FIGURE 7 Maximum Non-Repetitive Forward Surge Current Uni-Directional only

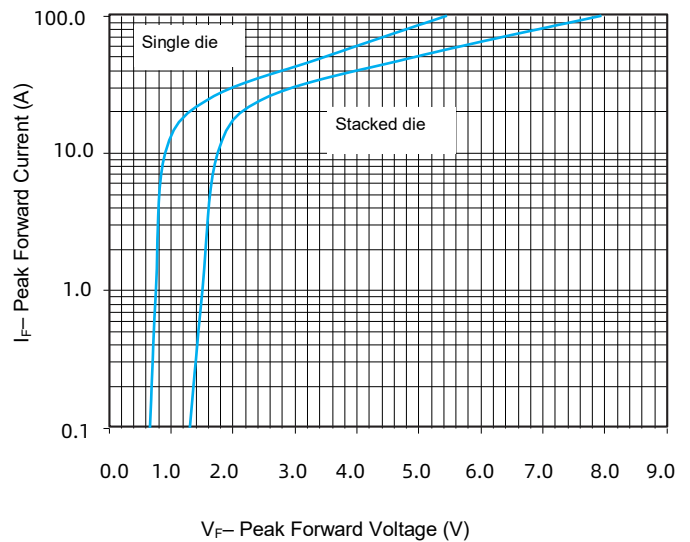

FIGURE 8 Peak Forward Drop vs Peak Forward Current (Typical Values)

Environmental Specifications

High Temp. Storage	JESD22-A103
HTRB	JESD22-A108
Temperature Cycling	JESD22-A104
MSL	JESDEC-J-STD-020, Level 1
H3TRB	JESD22-A101
RSH	JESD22-A111

Physical Specifications

Weight	0.003 ounce, 0.093 grams
Case	JESD22DO214AA. Molded plastic body over glass passivated junction
Polarity	Color band denotes positive end (cathode) except Bidirectional
Terminal	Matte Tin-plated leads, Solderability per JESD22-B102

Soldering Parameters

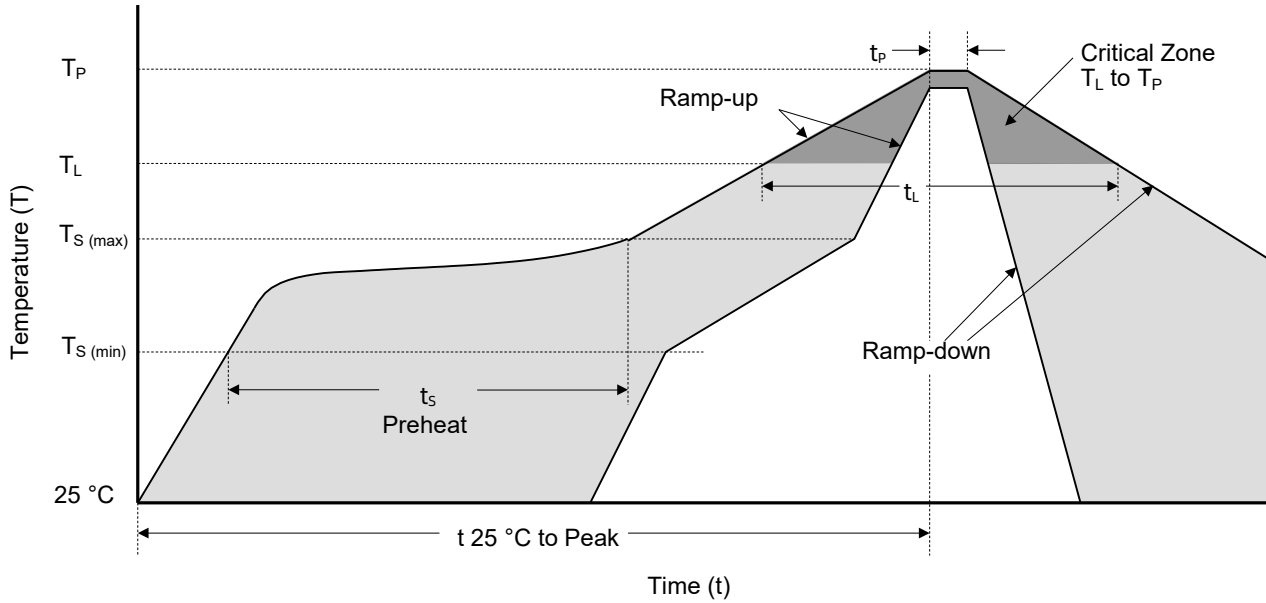

Reflowing Condition

Reflow Soldering Parameters		Lead-Free Assembly
Pre-heat	Temperature Min ($T_{S (min)}$)	150 °C
	Temperature Max ($T_{S (max)}$)	200 °C
	Time (min to max) (t_s)	60 ~ 120 seconds
Average Ramp Up Rate (Liquidus Temp (T_L) to Peak)		3 °C / second max.
$T_{S (max)}$ to T_L Ramp-up Rate		3 °C / second max.
Reflow	Temperature (T_L) (Liquidus)	217 °C
	Time (min to max) (t_L)	60 ~ 150 seconds
Peak Temperature (T_P)		260 ^{+0/-5} °C
Time of within 5 °C of Actual Peak Temperature (t_p)		20 ~ 40 seconds
Ramp-down Rate		6 °C / second max.
Time from 25 °C to Peak Temperature		8 Minutes max.
Do Not Exceed		260 °C

TVS Diodes

Transient Voltage Suppression Diodes

P6SMB Series

Packaging Information

Tape	Symbol	Dimension (mm)
	W	12.00+0.30/-0.10
	P ₀	4.00±0.10
	P ₁	8.00±0.10
	P ₂	2.00±0.05
	D ₀	1.55±0.05
	D ₁	1.55±0.05
	E	1.75±0.10
	F	5.50±0.05
	A ₀	3.78±0.10
	B ₀	5.65±0.15
	K ₀	2.70±0.10
	T	0.30±0.05

Reel Size	13" Reel	
	A	330 mm
	C	13.2 mm
	W ₁	12.5 mm

Part Number	Package	QTY (Reel)	Packaging Option	Packaging Specification
P6SMBxxx	DO-214AA	3000 PCS	Tape & Reel – 12 mm tape/13" reel	EIA STD RS-481

Glossary

Item	Description
V_C	Clamping Voltage Voltage across TVS in a region of low differential resistance that serves to limit the voltage across the device terminals.
V_R	Reverse Stand-off Voltage Maximum voltage that can be applied to the TVS without operation. NOTE : It is also shown as V_{WM} (maximum working voltage (maximum d.c. voltage)) and known as rated stand-off voltage (V_{so}).
I_R	Reverse Leakage Current Current measured at V_R . NOTE : Also shown as I_D for stand-by current.
V_{BR}	Breakdown Voltage Voltage across TVS at a specified current I_T in the breakdown region.
I_{PPM}	Rated Random Recurring Peak Impulse Current Maximum-rated value of random recurring peak impulse current that may be applied to a device.
$P_{M(AV)}$	Rated Average Power Dissipation Maximum-rated value of power dissipation resulting from all sources, including transients and standby current, averaged over a short period of time.
P_{PPM}	Rated Random Recurring Peak Impulse Power Dissipation Maximum-rated value of the product of rated random recurring peak impulse current (I_{PPM}) multiplies by specified maximum clamping voltage (V_C).
C_J	Capacitance Capacitance across the TVS measured at a specified frequency and voltage.
V_{FS}	Peak Forward Surge Voltage Peak voltage across an TVS for a specified forward surge current (I_{FS}) and time duration. NOTE : Also shown as V_F .
I_{FS}	Forward Surge Current Pulsed current through TVS in the forward conducting region. NOTE : Also shown as I_F .
$\alpha_{V(BR)}$	Temperature Coefficient of Breakdown Voltage The change of breakdown voltage divided by the change of temperature.
I_{PP}	Peak pulse Current Peak pulse current value applied across the TVS to determine the clamping voltage V_C for a specified wave shape.
I_T	Pulsed D.C. Test Current Test current for measurement of the breakdown voltage V_{BR} . This is defined by the manufacturer and usually given in milliamperes with a pulse duration of less than 40 ms. NOTE : Also shown as I_{BR} .

—(GB-T 18802.321 / IEC 61643-321 / JESD210A)



ATTENTION

Usage

1. TVS must be operated in the specified ambient temp.
2. Do not clean the TVS with strong polar solvent such as ketone, esters, benzene and halogenated hydrocarbon, to avoid damaging the encapsulating layer.
3. Please do not apply severe vibration, shock or pressure to TVS, to avoid element cracking.

Replacement

1. If TVS is visually damaged, please replace it.
2. TVS is a non-repairable product. For safety sake, please use equivalent TVS for replacement.

Storage

1. Storage Temp. Range: (-55 to 150) °C.
2. Do not store the TVS at the high temp., high humidity or corrosive gas environment, to avoid influencing the solder-ability of the lead wires. The product shall be used up within 1 year after receiving the goods.

Environmental Conditions

1. TVS should not be exposed to the open air, nor direct sunshine.
2. TVS should avoid rain, water vapor or other condition of high temp. and high humidity.
3. TVS should avoid sand dust, salt mist, or other harmful gases.

Max. Typical Capacitance of TVS

The typical capacitance of TVS is listed in the specifications. Designers may refer to it when designing TVS in High frequency circuit.

Installation Mechanical Stress

1. Do not knock TVS when installing, to avoid mechanical damage.
2. Please do not apply severe vibration, shock or pressure to TVS, to avoid surface resin or element cracking.

Transient Voltage Suppressor (Surface Mount) Features Overview

Package Type									Series
DO-221AC	○	○	○	○	○	SMA6L	○	○	○
DO-214AA	○	○	○	○	○	○	SACB	SMBJ	P6SMB
DO-214AB	○	○	○	○	○	○	○	○	○
DO-214AC	○	○	SMAJ	P4SMA	SMA6J	○	○	○	○
SOD-123FL	SMF	P4SMF	○	○	○	○	○	○	○
SMT0-218	○	○	○	○	○	○	○	○	○
Product Outline (mm)									
V_R / V_{WM} (V) Reverse Stand-off Voltage	5.0 ~ 250	5.0 ~ 85	5.0 ~ 440	5.8 ~ 468	5.0 ~ 250	5.0 ~ 50	5.0 ~ 440	5.8 ~ 512	
P_{PPM} (W) (10/1000 μ s) Rated Peak ImPulse Power Dissipation	200		400		600	500		600	
I_{PPM} (kA)(8/20 μ s) Rated Peak ImPulse Current					○				
Operating Temperature (°C)	-55 to +150								

Transient Voltage Suppressor (Surface Mount) Features Overview

Package Type	Series									
	DO-221AC	DO-214AA	DO-214AB	DO-214AC	SOD-123FL	SMT0-218	SPC1	SPC3	SPC6	SPC10
	○	○	○	○	○	○	○	○	○	○
	○	○	○	○	○	○	○	○	○	○
	SMCJ	1.5SMC	3.0SMCJ	SMDJ	5.0SMDJ					
	○	○	○	○	○					
	○	○	○	○	○					
	○	○	○	○	○	SPC1	SPC3	SPC6	SPC10	
Product Outline (mm)										
V_R / V_{WM} (V) Reverse Stand-off Voltage	5.0 ~ 440	5.8 ~ 512	5.0 ~ 440	12 ~ 170	380 / 430	66	58 ~ 76	58 ~ 86		
P_{PPM} (W) (10/1000 μ s) Rated Peak ImPulse Power Dissipation	1500	3000	5000							
I_{PPM} (kA)(8/20 μs) Rated Peak ImPulse Current						1	3	6	10	
Operating Temperature (°C)		-55 to +150					-55 to +125			

